

Przedstawiciel w Polsce:
 A&A Consulting Sp. z o.o.
 tel. 503640446
 e-mail: biuro@a-and-a.pl
 www.a-and-a.pl

Szklarnia MICRO 1.85x1.85m					
					Strona tytułowa
					Strona 1

SPECYFIKACJA TECHNICZNA

No.	Opis	jednostka	Ilość
	Rama szklarni MICRO 1,85x1,85m		
1	Wkręty do ramy 5,5x19	szt.	240
2	Wkręty do poliwęglanu 4,8x19	szt.	280
3	Wkręty samowierzące 4,8x19	szt.	100
4	Podkładki do poliwęglanu 5.5x30x1.0mm	szt.	250
5	Blachy dachowe 1,05m	szt.	6
6	Klamka	szt.	2
7	Zawiasy	szt.	4
8	Haczyki	szt.	2
9	Latch	szt.	1
10	Ogranicznik drzwi	szt.	4
11	Poliwęglan 2,1x6m + 2,1x3,34m	arkusz	2+1

Nazwa	Ilość
FW 2	1
D	4
Frame	1
S1	4
FW1	1
Door	1
Window	1
Roof window	optional
Shelf	optional

Uwaga!

Rama szklarni przeznaczona jest do montażu na fundamencie.
W sezonie zimowym należy usunąć pokrywę śnieżną z dachu szklarni i w razie potrzeby zainstalować tymczasowe drewniane belki nośne.

Przedstawiciel w Polsce:
A&A Consulting Sp. z o.o.
tel. 503640446
e-mail: biuro@a-and-a.pl
www.a-and-a.pl

Szklarnia MICRO 1.85x1.85m					
					Specyfikacja
					Strona 2

Przedstawiciel w Polsce:
 A&A Consulting Sp. z o.o.
 tel. 503640446
 e-mail: biuro@a-and-a.pl
 www.a-and-a.pl

Rysunek	FW2	Ilość	1	Wkręty	45
---------	-----	-------	---	--------	----

Item ID	QTY	Length
1,8	2	~ 1848.1 mm
2,7	2	~ 1263.1 mm
3,6	2	~ 836.2 mm
4,5	2	~ 1818.6 mm
9	1	~ 1839.5 mm
10,11	2	~ 1260.6 mm
12	1	~ 629.7 mm
łącznie		16.522

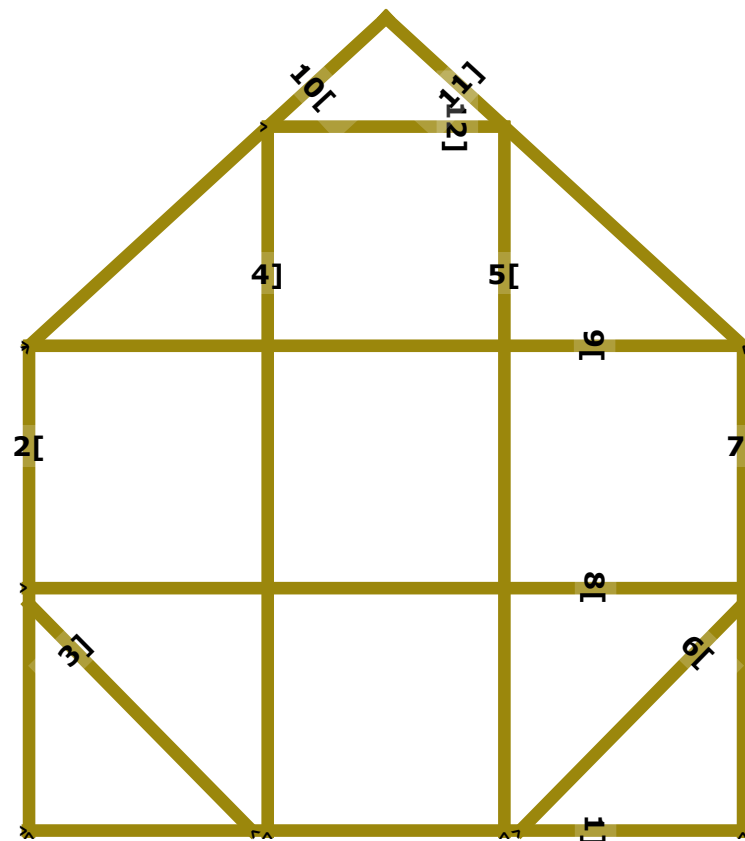

[Wspornik wskazuje orientację profilu

Szklarnia MICRO 1.85x1.85m				 WEIS A	
				Frame set: FW2	

Przedstawiciel w Polsce:
 A&A Consulting Sp. z o.o.
 tel. 503640446
 e-mail: biuro@a-and-a.pl
 www.a-and-a.pl

Rysunek	D	Ilość	4	Wkręty	12
---------	---	-------	---	--------	----

Item ID	QTY	Length
2,4	2	~ 652.5 mm
3	1	~ 1001.0 mm
1,5	2	~ 863.1 mm
Łącznie		4.032

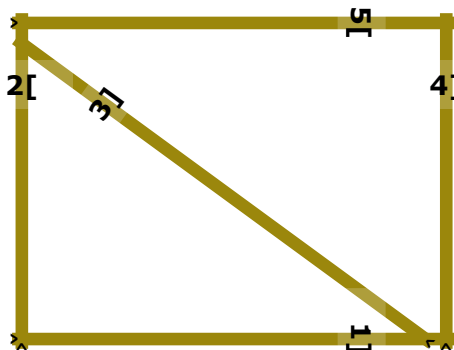

[Wspornik wskazuje orientację profilu

Szklarnia MICRO 1.85x1.85m				 WEIS A	
				Frame set: D	
				Strona 4	

Przedstawiciel w Polsce:
 A&A Consulting Sp. z o.o.
 tel. 503640446
 e-mail: biuro@a-and-a.pl
 www.a-and-a.pl

Rysunek	Frame	Ilość	1	Wkręty	18
----------------	-------	--------------	----------	---------------	-----------

Item ID	QTY	Length
2,5	2	~ 786.9 mm
3,6	2	~ 1260.9 mm
1,4	2	~ 1264.2 mm
7	1	~ 629.7 mm
łącznie		7.253

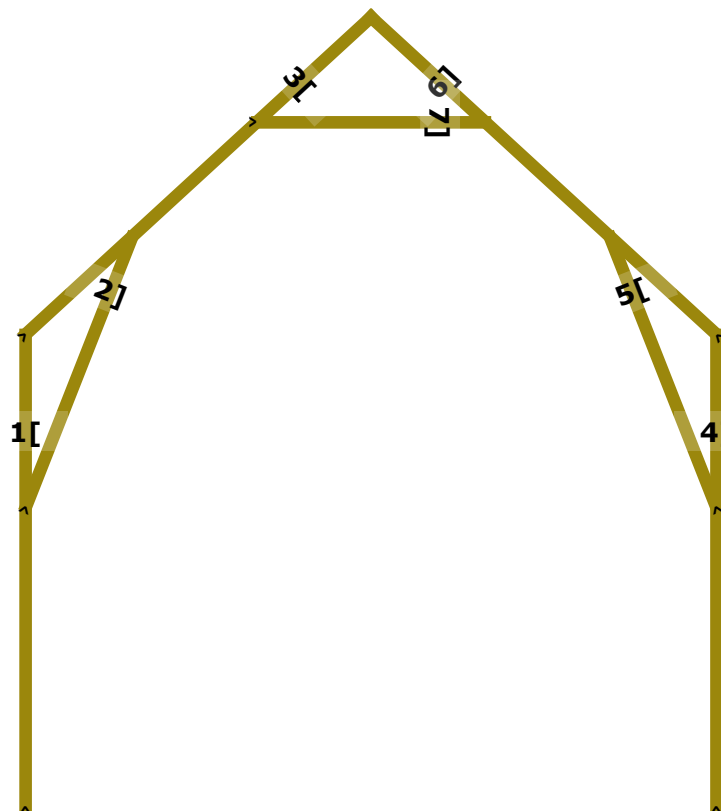

[Wspornik wskazuje orientację profilu

Szklarnia MICRO 1.85x1.85m				 WEIS A	
				Frame set: Frame	
				Strona 5	

Przedstawiciel w Polsce:
 A&A Consulting Sp. z o.o.
 tel. 503640446
 e-mail: biuro@a-and-a.pl
 www.a-and-a.pl

Rysunek	S1	Ilość	4	Wkręty	8
----------------	----	--------------	---	---------------	---

Item ID	QTY	Length
2,4	2	~ 652.5 mm
1,3	2	~ 863.1 mm
Łącznie		3.031



[Wspornik wskazuje orientację profilu

Szklarnia MICRO 1.85x1.85m				 WEIS A	
				Frame set: S1	
				Strona 6	

Przedstawiciel w Polsce:
 A&A Consulting Sp. z o.o.
 tel. 503640446
 e-mail: biuro@a-and-a.pl
 www.a-and-a.pl

Rysunek	FW1	Ilość	1	Wkręty	44
---------	-----	-------	---	--------	----

Item ID	QTY	Length
1	1	~ 1848.1 mm
2,7	2	~ 1263.1 mm
3,8	2	~ 836.2 mm
4,9	2	~ 642.9 mm
5,10	2	~ 638.8 mm
6,11	2	~ 1818.6 mm
12,13	2	~ 1260.6 mm
14	1	~ 629.7 mm
Łącznie		15.398

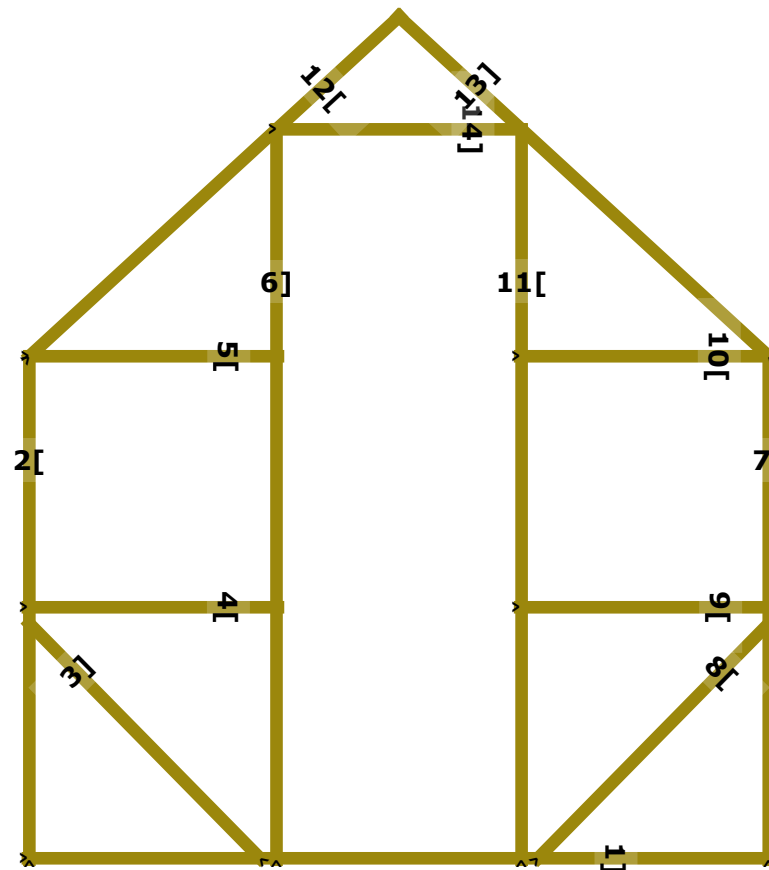

[Wspornik wskazuje orientację profilu

Szkłarnia MICRO 1.85x1.85m				 WEIS A	
				Frame set: FW1	
				Strona 7	

Przedstawiciel w Polsce:
 A&A Consulting Sp. z o.o.
 tel. 503640446
 e-mail: biuro@a-and-a.pl
 www.a-and-a.pl

Rysunek	Door	Ilość	1	Wkręty	24
---------	------	-------	---	--------	----

Item ID	QTY	Length
2,7	2	~ 1732.5 mm
3	1	~ 737.6 mm
1,4,5,8	4	~ 547.9 mm
6	1	~ 695.7 mm
łącznie		7.09

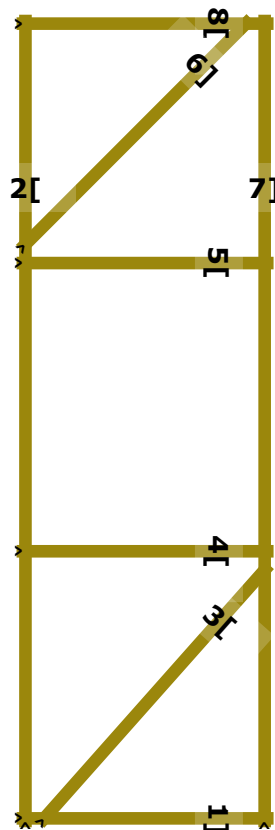

[Wspornik wskazuje orientację profilu

Szklarnia MICRO 1.85x1.85m					
				Frame set: Door	
				Strona 8	

Przedstawiciel w Polsce:
 A&A Consulting Sp. z o.o.
 tel. 503640446
 e-mail: biuro@a-and-a.pl
 www.a-and-a.pl

Rysunek	Window	Ilość	1	Wkręty	12
----------------	--------	--------------	----------	---------------	-----------

Item ID	QTY	Length
2,4	2	~ 503.4 mm
3	1	~ 663.7 mm
1,5	2	~ 547.9 mm
łącznie		2.766

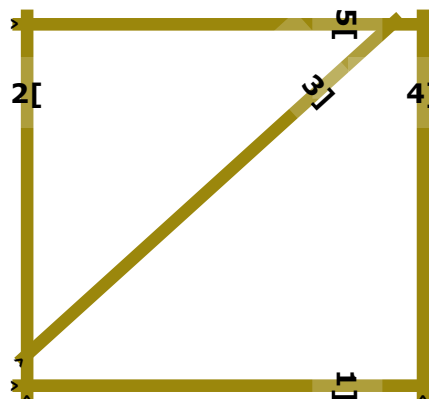

[Wspornik wskazuje orientację profilu

Szklarnia MICRO 1.85x1.85m				 WEIS A	
				Frame set: Window	
				Strona 9	

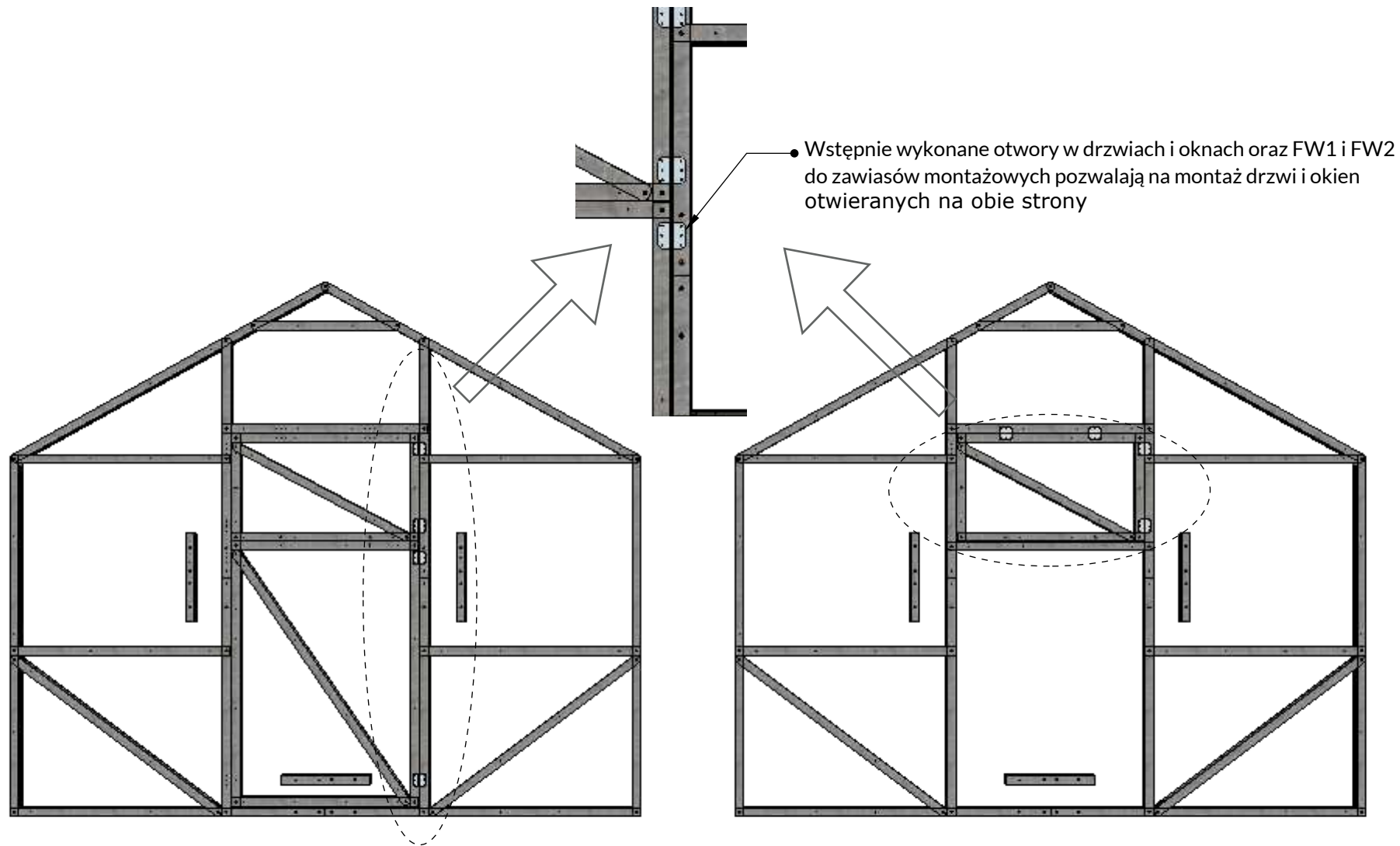

Przedstawiciel w Polsce:
 A&A Consulting Sp. z o.o.
 tel. 503640446
 e-mail: biuro@a-and-a.pl
 www.a-and-a.pl

Szklarnia MICRO 1.85x1.85m					
				Zawiasy do drzwi i okien	
				Strona 10	

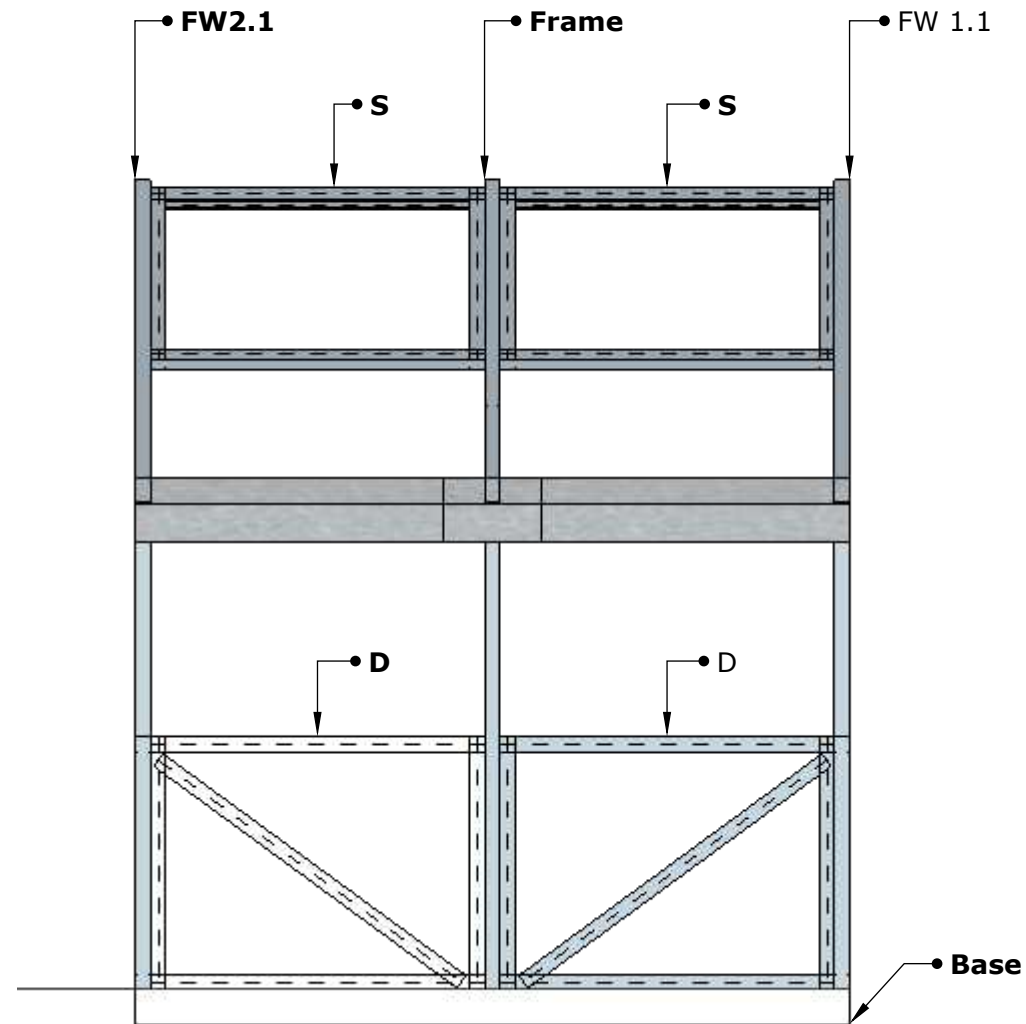

Przedstawiciel w Polsce:
 A&A Consulting Sp. z o.o.
 tel. 503640446
 e-mail: biuro@a-and-a.pl
 www.a-and-a.pl

Szkłarnia MICRO 1.85x1.85m					
					Montaż: widok z lewej strony
					Strona 11

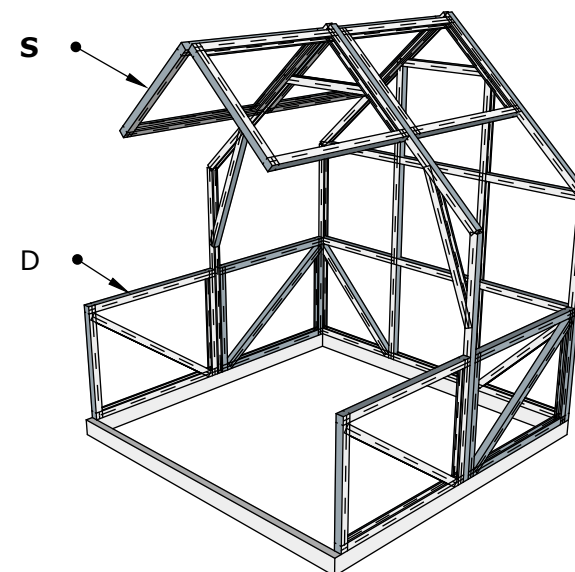
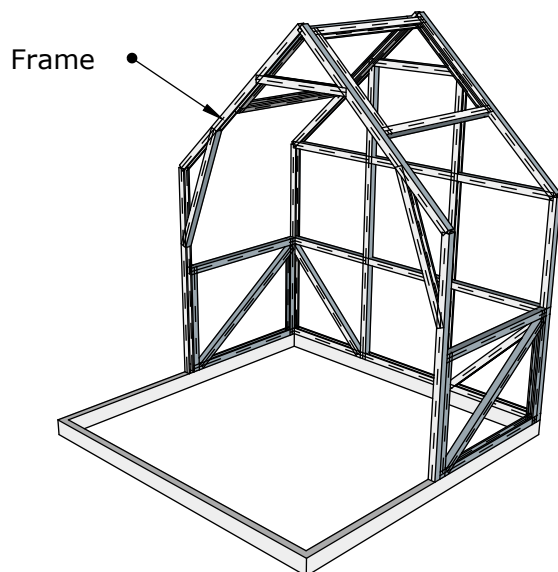
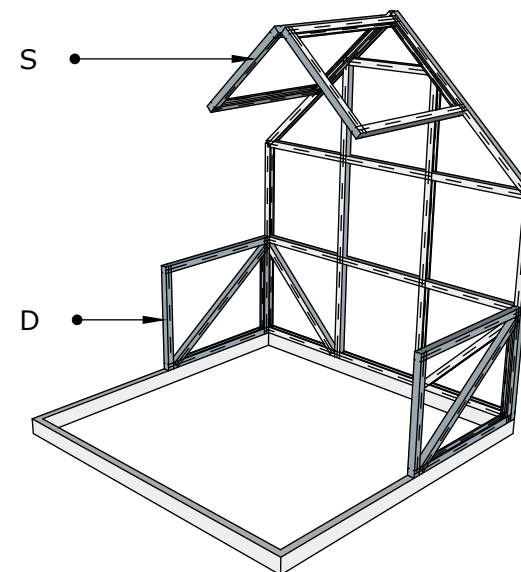
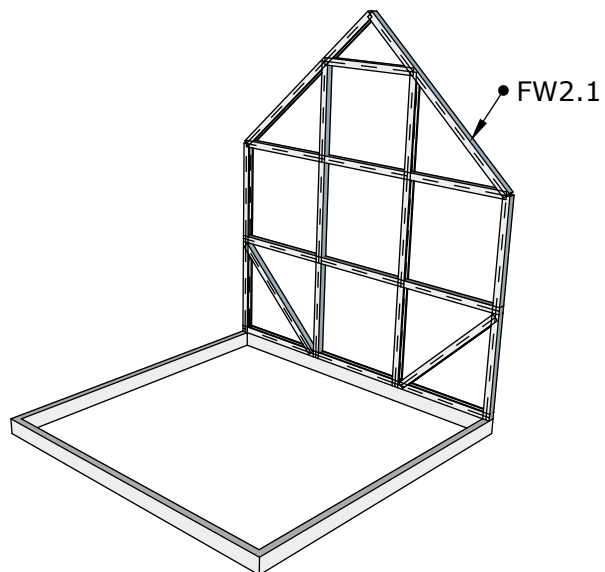

Przedstawiciel w Polsce:
 A&A Consulting Sp. z o.o.
 tel. 503640446
 e-mail: biuro@a-and-a.pl
 www.a-and-a.pl

Szklarnia MICRO 1.85x1.85m



Krok montażu 1-4

Strona 12

FW 1.1

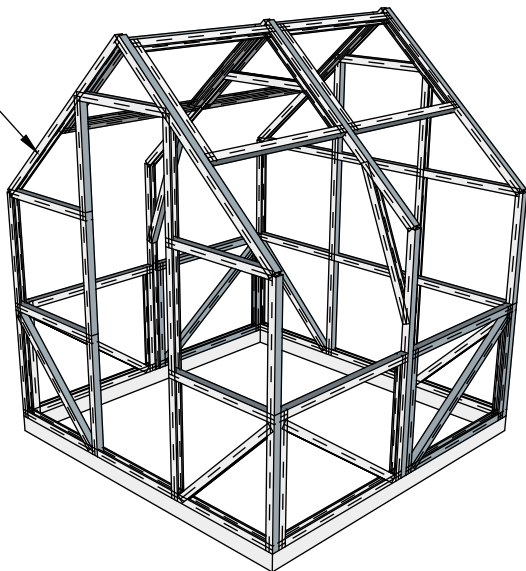

Door

Window

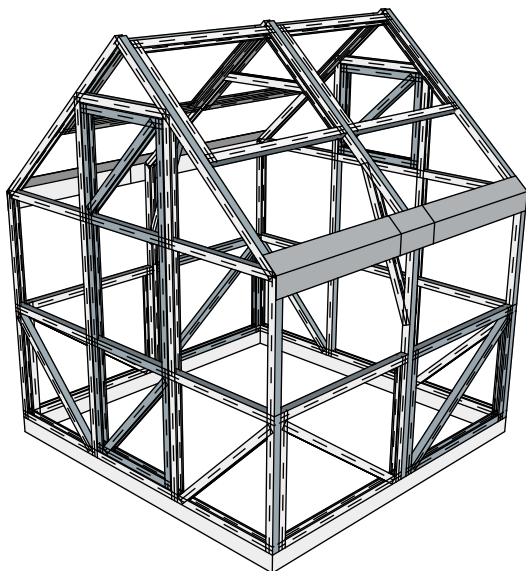
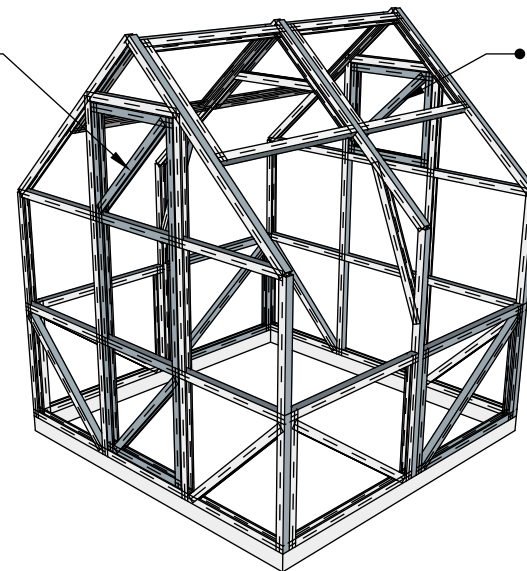

Przedstawiciel w Polsce:
A&A Consulting Sp. z o.o.
tel. 503640446
e-mail: biuro@a-and-a.pl
www.a-and-a.pl

Szklarnia MICRO 1.85x1.85m



Krok montażu 5-8

Strona 13

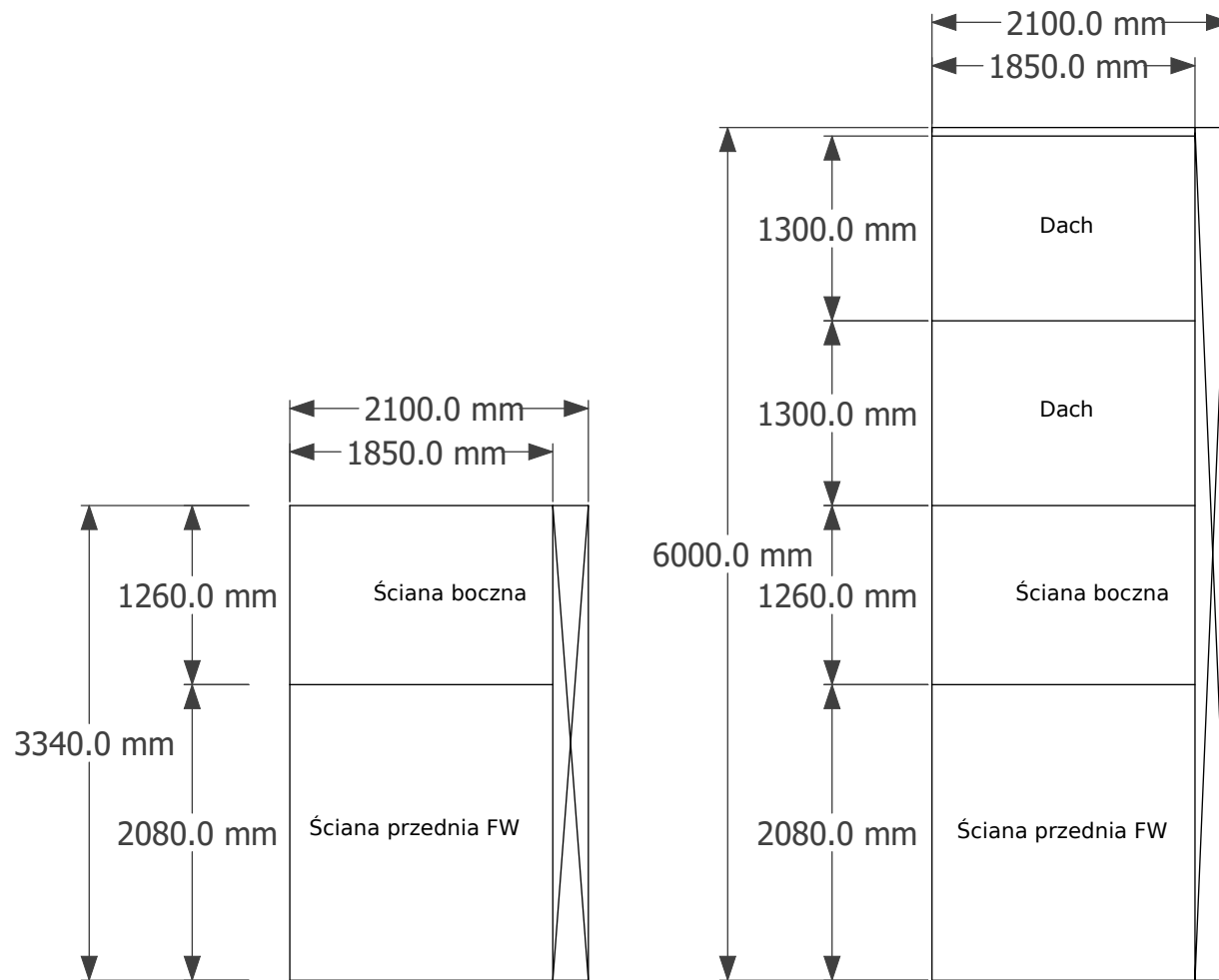

Przedstawiciel w Polsce:
 A&A Consulting Sp. z o.o.
 tel. 503640446
 e-mail: biuro@a-and-a.pl
www.a-and-a.pl

Szklarnia MICRO 1.85x1.85m				 WEIS A	
				Układ z poliwęglanu	
				Strona 14	